

Coremus™ Broken Implant Extractor System

Guidance for use



Contents

| | |
|--|-----|
| Inspection Before and After Each Use | 3 |
| Cleaning | 3 |
| Broken Implant Extractor System - Container 1 | 4 |
| Broken Implant Extractor System - Container 2 | 5 |
| Guidelines For Broken Nail Removal Using The Broken Nail Extractors | 6 |
| Guidelines For The Removal Of Broken Nails And Implant Stems Using Tubular Cutters | 7 |
| Guidelines For The Removal Of Broken Implant Stems Using The Target Device | 8-9 |
| Coremus Broken Implant Extractor System - Container 1 Contents List | 10 |
| Coremus Broken Implant Extractor System - Container 2 Contents List | 11 |

Before and after...

Before and After Each Use Ensure That:

- All drill bits, screw threads, screwdrivers and cutting devices are examined for damage.

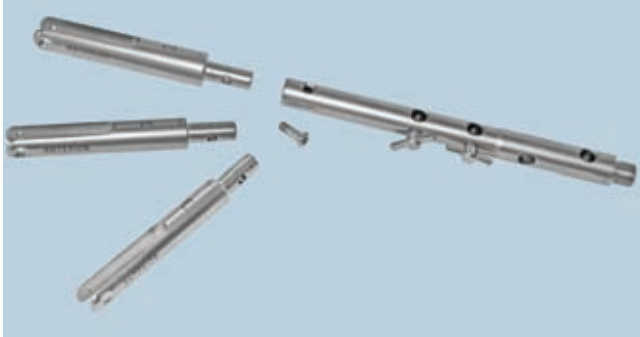

- The target assembly drill guides (CES-TD-07/09/11) fit securely onto target assembly main shaft (CES-TD-01)



- The screws located in the target assembly drill guides are the correct length for the 15mm, 16mm or 18mm diameters
- The twist drills (CES-D-01) slide through knurled drill sleeve on target assembly
- The twist drill (CES-D-02) slides through drill guide once the knurled drill sleeve is removed
- The tommy bar passes easily through the hole at the end of the target assembly
- All hex drivers locate securely into corresponding grub screws
- The broken nail extractors (CES-NE-01/02/03) have adequate distal end angles (these can be adjusted) and undamaged teeth



- The tubular coring devices are assembled correctly and all screws are tightened

Cleaning – Before and After Each Use Ensure That:

- Disassemble the target device and the three coring devices
- Check that the drill sleeves of the target device and all threaded components internal and external are clean and free of bone debris
- Check that the internal and external surfaces, including threads, of the tubular coring devices are clean and free of bone debris, agitate with a soft brush if necessary

Do not use wire wool or abrasive materials.

Broken Implant Extractor System - Container 1

Container 1:
Coremus Broken
Implant Extractor System
CES-BIE-SYS

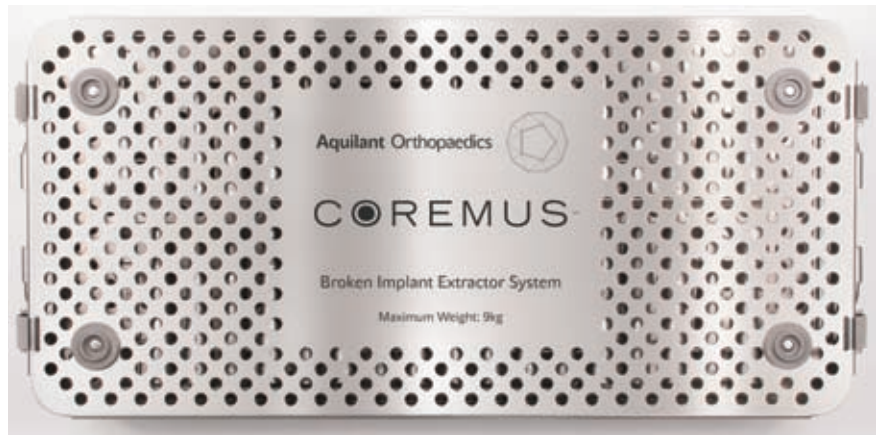

Container 1:
CES-BIE-TAR
For list of tray contents please see
page 10.

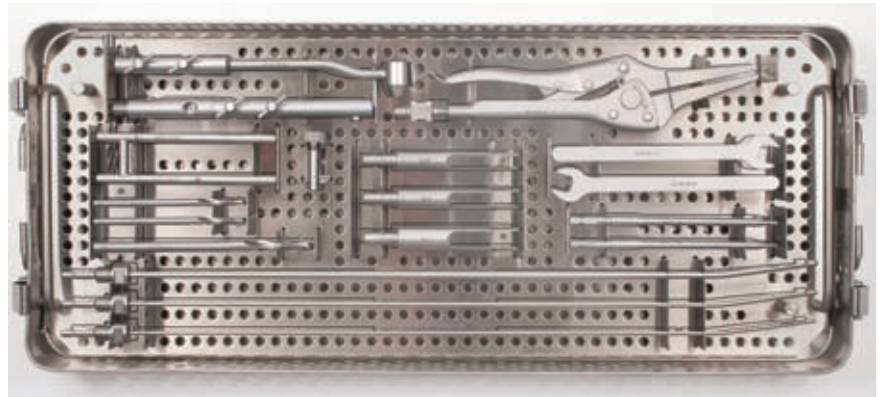

Broken Implant Extractor System - Container 2

Container 2:
Coremus Broken
Implant Extractor System
CES-BIE-SYS

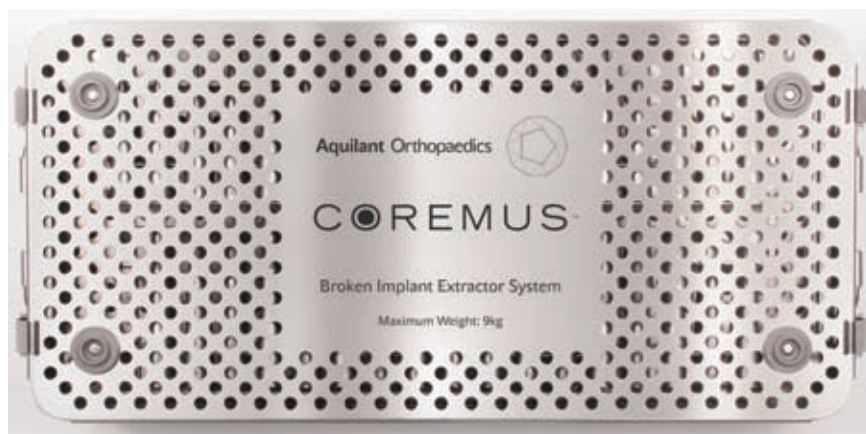

Container 2:
CES-BIE-CUT
For list of tray contents please see
page 11.

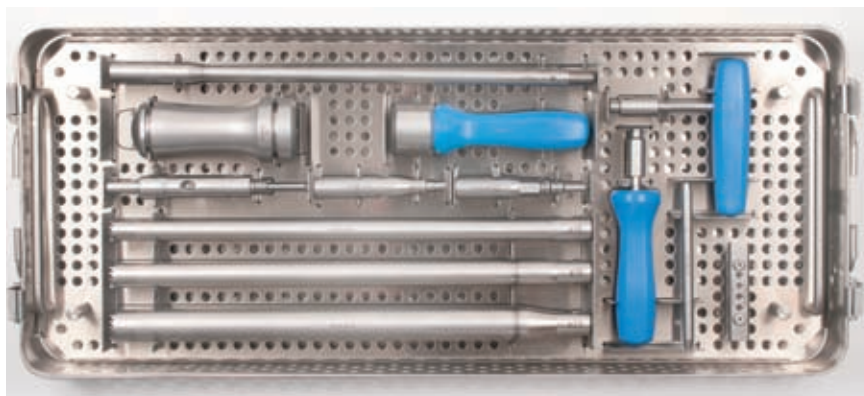

Guidelines For Broken Nail Removal Using The Broken Nail Extractors and the Coremus IM Nail Extraction Kit

- 1 Identify the broken medullary nail to be removed, select the corresponding bolt from the Coremus IM Nail Extraction Kit using the key.

Note for steps 1-9 please refer to Guidance for use for the Coremus IM Nail Extraction Kit for further details.

- 2 Expose all transverse locking screws, clear soft tissue and debris from all screw heads using the bone pick from the Coremus IM Nail Extraction Kit.
- 3 Remove screws, and end cap from the IM nail if present, with the corresponding screwdrivers identified from the Coremus IM Nail Extraction Kit key.
- 4 Clear any soft tissue and debris from the proximal internal threads of the IM nail.
- 5 Offer the correct bolt into the proximal fragment of the nail and screw in fully.
- 6 In the event of restricted access the extension bolt can be attached to the chosen extraction bolt prior to insertion into the IM nail.
- 7 Once the extraction bolt has been screwed fully into the IM nail, attach the sliding hammer shaft by screwing it onto the extraction bolt.
- 8 Attach the sliding hammer to the sliding hammer shaft.
- 9 Finally screw the sliding hammer handle onto the sliding hammer shaft and proceed with extraction using short sharp strokes.



- 10 On removal of the IM nail check the external diameter at the broken end.

- 11 Introduce a guidewire through the proximal femur and continue down through the centre of the distal fragment of the IM nail.
- 12 Select a cannulated flexible reamer (AO type) 1-2mm larger in diameter than the measured external diameter of the extracted fragment.
- 13 Proceed to ream over the guidewire down to the proximal end of the distal fragment, this will ensure any bony obstructions will be removed facilitating a clear extraction path.



- 14 Choose an appropriate size broken nail extractor (CES-NE-01/02/03) attach it to offset 'T' handle (CES-1-04) pass it through the proximal femur and down through the distal fragment of the IM nail. At this point you should feel a click as the tooth of the extractor passes through, and locks on to the bottom of the nail. Proceed with extraction.



- 15 In the event of an unsuccessful extraction, it is possible with *extreme caution to use the sliding hammer. First remove the offset 'T' handle from the extractor and replace it with the sliding hammer shaft (CES-SH-06) attach the sliding hammer weight (CES-SH-02) to the shaft and finally the sliding hammer handle (CES-SH-03) to the shaft.

***Excessive force could break the hook attached to the bottom of the intramedullary nail.**

Guidelines For The Removal Of Broken Nails And Implant Stems Using Tubular Cutters

- 1 Remove the threaded fragment of the broken intramedullary nail or femoral component using either the Coremus IM Nail Extractor System or a femoral component extractor.
- 2 Identify the size of the broken medullary nail or broken implant stem to be extracted by measuring the distal portion of the proximal fragment removed.

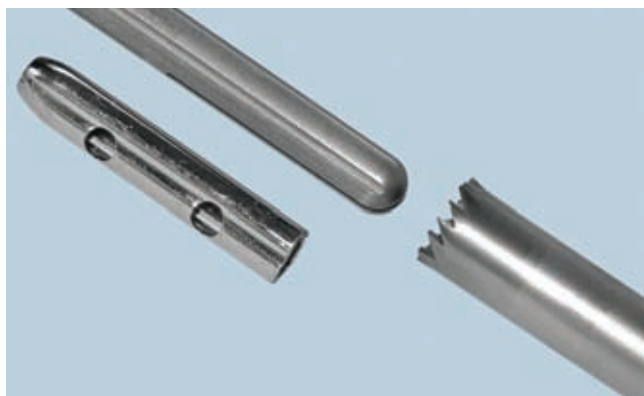

- 3 Using the extracted proximal fragment, select the smallest tubular cutter (CES-CD-04/05/06) that will slide over the widest portion of the fragment, this will ensure minimal bone removal during reaming.



- 4 Attach the Jacobs cutter tube body (CES-CD-07), with two screws (CES-CD-08), onto the tubular cutter and then on to a slow speed high torque power source.



- 5 Hudson, and AO adaptors (CES-CD-07/09/10) can be screwed over the top of the Jacobs cutter tube body if required, and secured with two grub screws (CES0CD-11).
- 6 Proceed to core over the fragment, removing the tubular cutter frequently to clean the teeth this is most important as blocked teeth will only generate heat and not cut.
- 7 In most instances, when half or most of the fragment has been reamed, the fragment will become trapped inside the tube by cement or bone debris. At this point extraction can be achieved by removing the tube.
- 7 In the event of entrapment of the fragment and an unsuccessful extraction, it is possible with *extreme caution to use the sliding hammer attachment. First remove the power source and adaptor (if used) replace it with the sliding hammer shaft (CES-SH-06) attach the sliding hammer weight (CES-SH-02) to the shaft and finally the sliding hammer handle (CES-SH-03) to the shaft.

***Excessive force should be avoided as this may result in a fracture.**

Tubular cutter sizes:

| | |
|-----------------------|------------------------|
| 25mm outside diameter | 21.5mm inside diameter |
| 19mm outside diameter | 15.5mm inside diameter |
| 16mm outside diameter | 12.5mm inside diameter |

Guidelines For The Removal Of Broken Implant Stems Using The Target Device

- 1 Using a femoral component extractor, remove the proximal fragment of the implant.
- 2 Remove as much remaining bone cement from the proximal femur down to the distal fragment.
- 3 Clear sufficient bone cement from around the top of broken fragment to enable the seating of an appropriate size target device attachment (CES-TD-07, 09, or 11).



- 4 Remove the screw from the target device main shaft (CES-TD-01). Attach the appropriate target device attachment (CES-TD-07, 09, or 11) and replace screw.



- 5 Connect the short arms of the parallel slider bar (CES-TD-06) to the target device main shaft and secure with wing nuts.

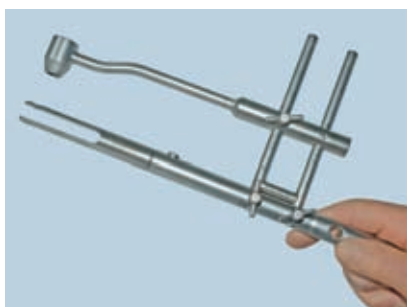

- 6 Connect the drill guide (CES-TD-03) to the long arms of the parallel slider bar (CES-TD-04) and secure loosely with the wing nuts.



Ensure that the threaded part of the target device attachment (CES-TD-07, 09, or 11) is furthest away from the drill guide.



- 7 Locate the target device attachment (CES-TD-07, 09, or 11) down the canal and over the broken fragment.



- 8 An exposure is created adjacent to the drill guide on the parallel slider bar. Adjust the drill guide on the parallel slider bar so that the drill guide makes contact with the bone.



- 9 The 8mm twist drill (CES-D-02) is then inserted through the drill guide and through the bone until contact is made with the target device attachment (CES-TD-07, 09, or 11).

Guidelines For The Removal Of Broken Implant Stems Using The Target Device



- 10 The knurled drill sleeve (CES-TD-04) is then introduced and adjusted so that the drill sleeve fits into the hole created by the 8mm bone drill.



The tungsten carbide twist drill (CES-D-01) is now used to drill through the target device attachment and through the broken fragment.

Caution should be taken to only drill through the implant as proceeding further may damage the screw threads on the target device attachment.



- 11 Remove the knurled drill sleeve and adjust the target assembly back over the drill hole. Insert the corresponding extraction screw for the drill guide chosen through the drill guide and fragment. Secure with the hex driver.



- 12 Undo the wing nuts on the target assembly and remove parallel bars and drill guide.



- 13 Attach the sliding hammer shaft (CES-SH-06) to the target device main shaft. Attach the sliding hammer weight (CES-SH-02) to the shaft and finally the sliding hammer handle (CES-SH-03) to the shaft.



- 14 Proceed extraction using short sharp strokes.

CES-BIE-TAR Coremus Broken Implant Extractor System Container 1 Contents List

| No. | Description | Quantity |
|-----------|--|----------|
| CES-C-03 | Coremus Extractor System - Broken Implant - Case - Lid - 600mm x 250mm | 1 |
| CES-C-04 | Coremus Extractor System - Broken Implant - Case - Base - 600mm x 250mm x 65mm | 1 |
| CES-T-06 | Coremus Extractor System - Broken Implant - Tray For Target Device | 1 |
| CES-SH-05 | Coremus Extractor System - Sliding Hammer - Spanner | 2 |
| CES-DS-05 | Coremus Extractor System - Driver Shaft With Coremus QC Fitting - Hex - 2.5mm | 1 |
| CES-DS-06 | Coremus Extractor System - Driver Shaft With Coremus QC Fitting - Hex - 3.0mm | 1 |
| CES-I-06 | Coremus Extractor System - Power Pliers With Sliding Hammer Attachment | 1 |
| CES-NE-01 | Coremus Extractor System - Broken Nail Extractor - 3.2mm | 1 |
| CES-NE-02 | Coremus Extractor System - Broken Nail Extractor - 4.0mm | 1 |
| CES-NE-03 | Coremus Extractor System - Broken Nail Extractor - 5.5mm | 1 |
| CES-TD-01 | Coremus Extractor System - Target Device - Main Shaft | 1 |
| CES-TD-02 | Coremus Extractor System - Target Device - Main Shaft To Fork Connecting Screw | 1 |
| CES-TD-03 | Coremus Extractor System - Target Device - Drill Guide Shaft | 1 |
| CES-TD-04 | Coremus Extractor System - Target Device - Drill Guide Sleeve | 1 |
| CES-TD-06 | Coremus Extractor System - Target Device - Parallel Slider Bar | 1 |
| CES-TD-07 | Coremus Extractor System - Target Device - Attachment - 15mm | 1 |
| CES-TD-08 | Coremus Extractor System - Target Device - Attachment Screw - 15mm | 1 |
| CES-TD-09 | Coremus Extractor System - Target Device - Attachment - 16mm | 1 |
| CES-TD-10 | Coremus Extractor System - Target Device - Attachment Screw - 16mm | 1 |
| CES-TD-11 | Coremus Extractor System - Target Device - Attachment - 18mm | 1 |
| CES-TD-12 | Coremus Extractor System - Target Device - Attachment Screw - 18mm | 1 |
| CES-D-01 | Coremus Extractor System - Drill - Tungsten Carbide Tip - 4.0mm x 110mm | 2 |
| CES-D-02 | Coremus Extractor System - Drill - 8.0mm x 160mm | 1 |

CES-BIE-CUT Coremus Broken Implant Extractor System Container 2 Contents List

| No. | Description | Quantity |
|-----------|---|----------|
| CES-C-03 | Coremus Extractor System - Broken Implant - Case - Lid - 600mm x 250mm | 1 |
| CES-C-04 | Coremus Extractor System - Broken Implant - Case - Base - 600mm x 250mm x 65mm | 1 |
| CES-T-05 | Coremus Extractor System - Broken Implant - Tray For Sliding Hammer | 1 |
| CES-SH-02 | Coremus Extractor System - Sliding Hammer - Weight | 1 |
| CES-SH-03 | Coremus Extractor System - Sliding Hammer - Handle | 1 |
| CES-SH-06 | Coremus Extractor System - Sliding Hammer - Shaft - Female Threaded End | 1 |
| CES-I-03 | Coremus Extractor System - Screwdriver Handle - Straight | 1 |
| CES-I-04 | Coremus Extractor System - Screwdriver Handle - Offset T | 1 |
| CES-I-07 | Coremus Extractor System - Tommy Bar - 8mm x 120mm | 1 |
| CES-CD-04 | Coremus Extractor System - Coring Device - Cutter Tube - 16mm | 1 |
| CES-CD-05 | Coremus Extractor System - Coring Device - Cutter Tube - 19mm | 1 |
| CES-CD-06 | Coremus Extractor System - Coring Device - Cutter Tube - 25mm | 1 |
| CES-CD-07 | Coremus Extractor System - Coring Device - Cutter Tube Body - Jacobs Fitting | 1 |
| CES-CD-08 | Coremus Extractor System - Coring Device - Cutter Tube Body - Screw | 2 |
| CES-CD-09 | Coremus Extractor System - Coring Device - Cutter Tube Adaptor - Hudson Fitting | 1 |
| CES-CD-10 | Coremus Extractor System - Coring Device - Cutter Tube Adaptor - Large AO Fitting | 1 |
| CES-TD-05 | Coremus Extractor System - Target Device - Thumb Screw | 4 |

Echo Orthopaedics Ltd

Unit 4
Highland Business Park
London Road
Bolney
West Sussex
RH17 5PX

T: +44(0) 1444 882210

E: info@echo-ortho.co.uk

www.echo-ortho.co.uk

Please note these "Guidelines for Use"
refer to general situations and
therefore individual surgeon
judgement is required.

 The medical products to which we assign
the CE mark comply with the council
directive 93/42/EEC corresponding to
their classification with the respective
conformity valuation process
93/42/EEC